

# Fan Clutch & Water Pump

## Fan Coupling



**Fan Clutch**

**Water Pump w/Fan Clutch**

**Water Pump**

**Shimadide**

**2018**  
**CATALOG**

# *Design-Box*

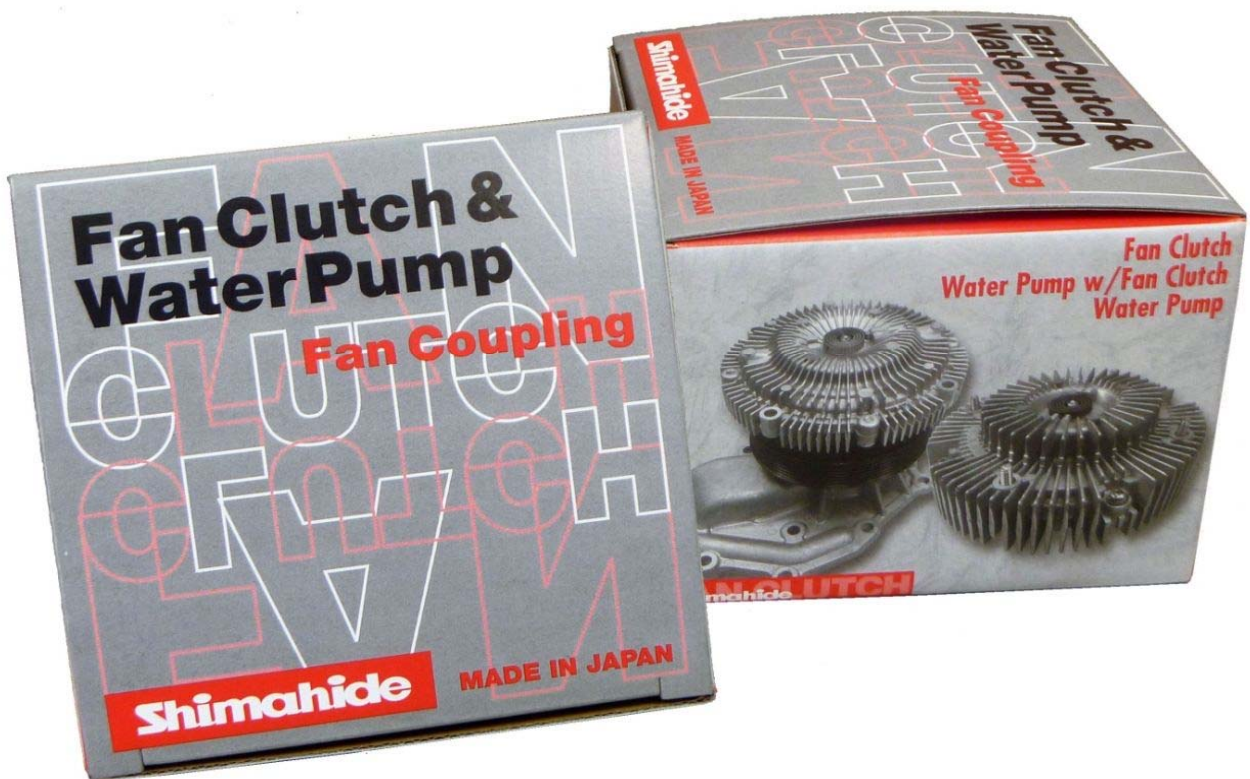

## Dimensions Standard

### Type A

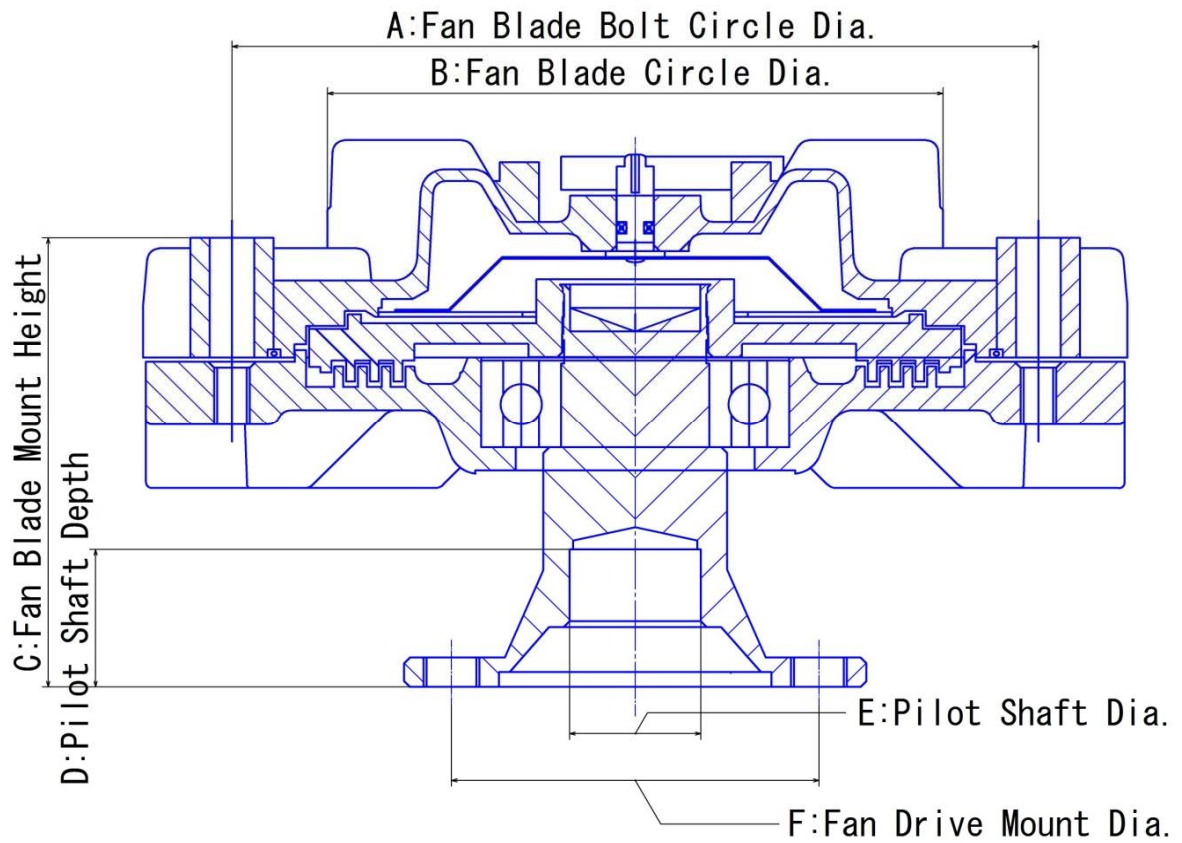

**Installation  
Sample Picture**



## Dimensions Standard

### Type B

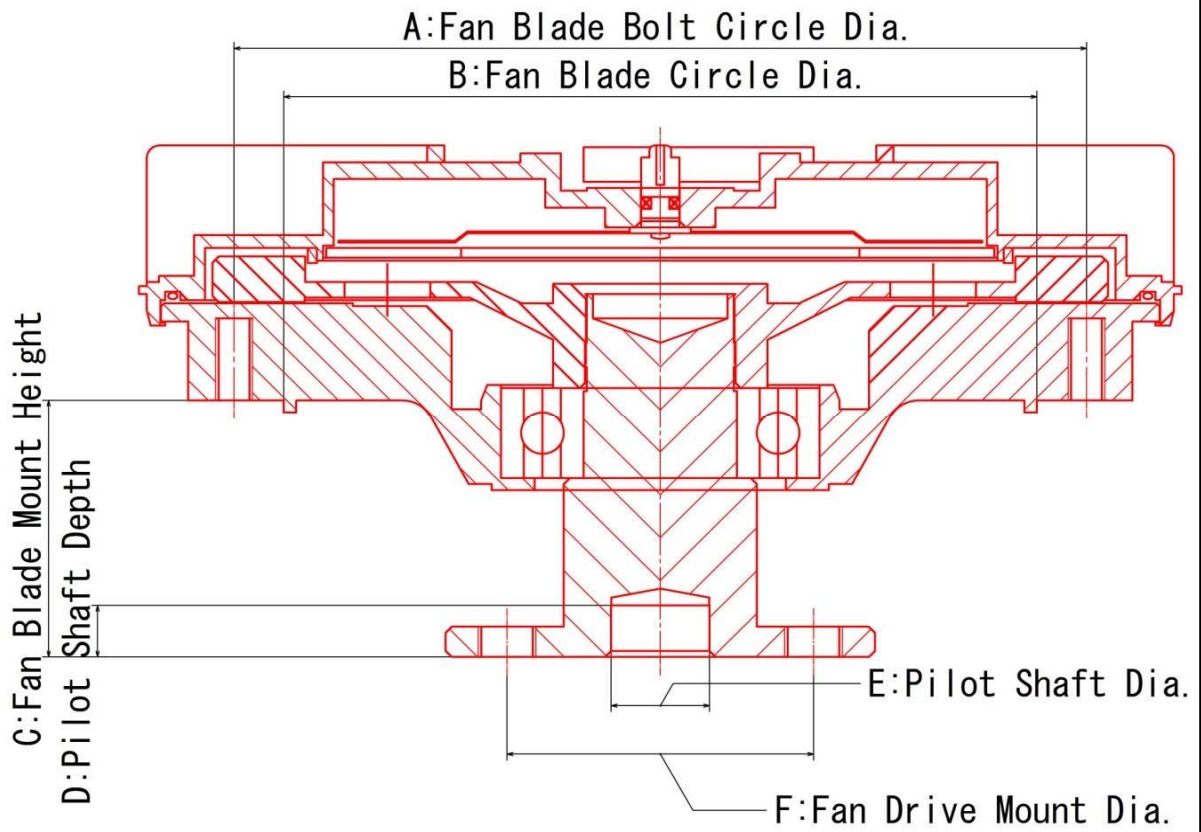

### Installation Sample Picture





	Year	Displacement	Engine Model	Water Pump No.	Fan Clutch No.	Cross Reference No.1	Cross Reference No.2
--	------	--------------	--------------	----------------	----------------	----------------------	----------------------

## TOYOTA

### Items in last 20 years

Gasoline	(03~05)	1,998cc	1TR-FE	16100-79445	<b>16210-75090</b>		
	(89~04)	2,438cc	1RZ/2RZ-E	16100-79265/455	<b>16210-75010</b>	16210-75020/30	
	(93~04)	2,693cc	3RZ-FE	16100-79245/445	<b>16210-75040</b>	16210-75060/80	
	(04~)	<b>2,693cc</b>	<b>2TR-FE</b>	16100-79445	<b>16210-0C010</b>	16210-75100/10	16210-75120
	(94~04)	3,378cc	5VZ-FE	16100-69395/405	<b>16210-62030</b>	16210-62011	
		3,456cc	2GR-FKS	16100-09720	<b>16210-0P020</b>		
	(05~09)	3,956cc	1GR-FE	16100-39405	<b>16210-31020</b>	16210-0P010	
	(09~)	<b>3,956cc</b>	<b>1GR-FE</b>	16100-39545	<b>16210-31030</b>	16210-31040	16210-0P020
	(98~06)	4,477cc	1FZ-FE	16100-69415	<b>16210-66010</b>	16210-66020/40	16210-66050
	(07~14)	4,608cc	1UR-FE	16380-38020 (Bracket)	<b>16210-38070</b>	16210-38071	
	(09~)	<b>4,608cc</b>	<b>1UR-FE</b>	16380-38020 (Bracket)	<b>16210-38080</b>	16210-38081	
	(98~05)	4,664cc	2UZ-FE	16307-0F010 (Bracket)	<b>16210-50050</b>	16210-50051/72	16210-50080/90
	(07~09)	4,664cc	2UZ-FE	16307-50012 (Bracket)	<b>16210-50100</b>	16210-50101/02	
	(07~14)	5,663cc	3UR-FE	16380-0S010 (Bracket)	<b>16210-38070</b>	16210-38071	
Diesel	(15~)	<b>2,393cc</b>	<b>2GD-FTV</b>	16100-19365	<b>16210-0E010</b>	16210-0E020	
	(01~06)	2,494cc	2KD-FTV	<b>16110-69045</b>	<b>16210-30010/11</b>	16210-30020	
	(05~)	<b>2,494cc</b>	2KD-FTV	16100-09260	<b>16210-0L010/11</b>	16210-30030/31	
	(15~)	<b>2,754cc</b>	<b>1GD-FTV</b>	16100-19365	<b>16210-11030</b>		
	(93~95)	2,982cc	1KZ-T	<b>16110-69045</b>	<b>16210-67010</b>		
	(96~02)	2,982cc	1KZ-TE	<b>16110-69045</b>	<b>16210-67030</b>	16210-67040	
	(01~)	<b>2,982cc</b>	<b>1KD-FTV</b>	<b>16110-69045</b>	<b>16210-30010/11</b>		
	(05~)	<b>2,982cc</b>	<b>1KD-FTV</b>	16100-09260	<b>16210-0L010/11</b>	16210-30030/31	
	(98~07)	2,986cc	5L-E	16100-59255	<b>16210-54200</b>	16210-54210/20	16210-05010
	(04~)	<b>4,009cc</b>	<b>N04C</b>	16100-78110	<b>16250-78110</b>	16250-78111	16250-E0251
	(07~)	<b>4,009cc</b>	<b>N04C</b>	16100-E0B60	<b>16250-78190</b>	S1625-01850	
	(99~07)	4,104cc	15B	16100-59295	<b>16210-58070</b>	16210-58060	
	(90~99)	4,164cc	1HD*1HZ	16100-19235	<b>16210-17020</b>	16210-17010	
	(98~07)	4,164cc	1HD*1HZ	16100-19235	<b>16210-17070</b>	16210-17050	
(99~15)	4,164cc	1HZ	16100-19235	<b>16210-17080</b>			
(07~)	<b>4,461cc</b>	<b>1VD-FTV</b>	16100-59365	<b>16210-51020</b>	16210-51030/31		

## HINO



Diesel	(06~11)	4,009cc	W04D	16100-E0151	<b>16250-E0280</b>	16250-78200	
--------	---------	---------	------	-------------	--------------------	-------------	--

### Items of very old model

	Maker	Displacement	Engine Model	Water Pump No.	Fan Clutch No.	Cross Reference No.1	Cross Reference No.2
	<b>TOYOTA</b>	2,366cc	22R	16110-38021	<b>16210-38050</b>	16210-38060	16210-38022/23/24
	<b>TOYOTA</b>	1,496*1781cc	5K*7K	16100-19045	<b>16210-13030</b>	16210-13040	
	<b>TOYOTA</b>	2,366cc	22RE	16100-39346	<b>16210-35020</b>		
	<b>TOYOTA</b>	2,366cc	22R	16110-39335	<b>16210-35011</b> <b>16210-64041/60/60</b>	16210-64010/20	16210-64030/40
	<b>TOYOTA</b>	1,968cc	18R	16120-34100	<b>16210-34100</b>	16210-34102	16210-31010
		1,812*1,998cc	2Y*3Y	16100-79035	<b>16210-72010</b>	16210-73010/40/41	16210-74020
	<b>TOYOTA</b>	2,446cc	2L	16100-59155	<b>16210-54140</b>	16210-54180	
	<b>DAIHATSU</b>		HDE	16100-87183-000	<b>16210-87103</b>	16210-87106	

# TOYOTA

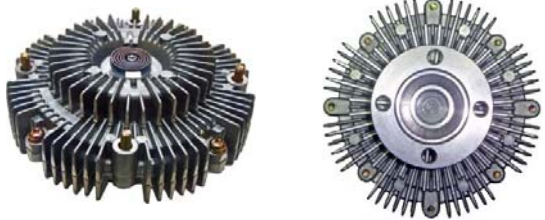
Item No.	Photo	Attachment	Size
16210-75090			<b>Type A</b> A=136.0 B=103.8 C=68.7 D=23.5 E=16.16 F=62.0
16210-75010 16210-75020/30			<b>Type A</b> A=122.0 B=103.8 C=52.0 D=23.5 E=16.16 F=62.0
16210-75040 16210-75060/80			<b>Type A</b> A=136.0 B=103.8 C=68.7 D=23.5 E=16.16 F=62.0
16210-0C010 16210-75100/10 16210-75120			<b>Type A</b> A=136.0 B=103.8 C=68.7 D=23.5 E=16.16 F=62.0
16210-62030 16210-62011			<b>Type A</b> A=136.0 B=103.8 C=67.0 D=23.5 E=16.16 F=62.0
16210-0P020			<b>Type A</b> A=136.0 B=103.8 C=88.4 D=23.5 E=16.16 F=62.0

Item No.	Photo	Attachment	Size
<b>16210-31020</b> 16210-0P010			<b>Type A</b> A=136.0 B=103.8 C=76.8 D=23.5 E=16.16 F=62.0
<b>16210-31030</b> 16210-31040			<b>Type A</b> A=136.0 B=103.8 C=88.4 D=23.5 E=16.16 F=62.0
<b>16210-66010</b> 16210-66020/40 16210-66050			<b>Type A</b> A=136.0 B=103.8 C=72.4 D=23.5 E=22.26 F=62.0
<b>16210-38070</b> 16210-38071  R			<b>Type A</b> A=174.0 B=153.8 C=82.0 D=17.0 E=38.26 F=68.0
<b>16210-38080</b> 16210-38081  R			<b>Type A</b> A=174.0 B=153.8 C=82.0 D=17.0 E=38.26 F=68.0
<b>16210-50050</b> 16210-50051/72 16210-50080/90  R			<b>Type A</b> A=136.0 B=103.8 C=65.4 D=24.0 E=16.16 F=74.0



Item No.	Photo	Attachment	Size
<p><b>16210-50100</b> 16210-50101/02</p> <p><b>R</b></p>			<p><b>Type A</b></p> <p>A=136.0 B=103.8 C=78.3 D=24.0 E=16.16 F=74.0</p>
<p><b>16210-0E010</b> 16210-0E020</p>			<p><b>Type A</b></p> <p>A=136.0 B=103.8 C=68.7 D=23.5 E=22.26 F=62.0</p>
<p><b>16210-30010</b> 16210-30011 16210-30020/30</p>			<p><b>Type A</b></p> <p>A=136.0 B=103.8 C=76.0 D=23.5 E=22.26 F=62.0</p>
<p><b>16210-0L010</b> 16210-0L011 16210-30030/31</p>			<p><b>Type A</b></p> <p>A=136.0 B=103.8 C=76.0 D=23.5 E=22.26 F=62.0</p>
<p><b>16210-11030</b></p>			<p><b>Type A</b></p> <p>A=136.0 B=103.8 C=68.7 D=23.5 E=22.26 F=62.0</p>
<p><b>16210-67010</b></p>			<p><b>Type A</b></p> <p>A=136.0 B=103.8 C=76.0 D=23.5 E=22.26 F=62.0</p>



# TOYOTA

Item No.	Photo	Attachment	Size
16210-67030 16210-67040			<b>Type A</b> A=136.0 B=103.8 C=76.0 D=23.5 E=22.26 F=62.0
16210-54200 16210-54210/20 16210-05010			<b>Type A</b> A=136.0 B=103.8 C=72.5 D=25.0 E=16.16 F=62.0
16250-78110 16250-78111 16250-E0251			<b>Type A</b> A=177.0 B=159.8 C=64.4 D=24.6 E=40.2 F=62.0
S1625-01850 16250-78190			<b>Type A</b> A=136.0 B=103.8 C=70.6 D=24.6 E=40.2 F=62.0
16210-58070 16210-58060			<b>Type A</b> A=136.0 B=103.8 C=67.0 D=23.5 E=16.16 F=62.0
16210-17020 16210-17010			<b>Type A</b> A=136.0 B=103.8 C=76.8 D=23.5 E=16.16 F=62.0

# TOYOTA

R Reverse Rotation

Item No.	Photo	Attachment	Size
16210-17070 16210-17050			<b>Type A</b> A=136.0 B=103.8 C=81.0 D=23.5 E=16.16 F=62.0
16210-17080			<b>Type A</b> A=136.0 B=103.8 C=97.3 D=23.5 E=16.16 F=62.0
16210-51020 16210-51030/31  R			<b>Type A</b> A=136.0 B=103.8 C=80.0 D=17.0 E=38.26 F=68.0

# HINO

16250-E0280 16250-78200			<b>Type A</b> A=153.0 B=136.8 C=57.7 D=24.6 E=40.26 F=62.0
----------------------------	---	--	--

	Year	Displacement	Engine Model	Water Pump No.	Fan Clutch No.	Cross Reference No.1	Cross Reference No.2
--	------	--------------	--------------	----------------	----------------	----------------------	----------------------

## NISSAN

### Items in last 20 years

Gasoline	(93~02)	2,389cc	KA24D	21010-86G00	<b>21082-86G00</b>	21082-86G0A	
	(12~)	2,488cc	QR25DE	21010-EA010	<b>21082-VW011</b>		
	(05~10)	2,488cc	QR25DE	21010-EA010	<b>21082-EA000</b>	21082-EA00A	21082-EA01A
	(12~)	2,488cc	QR25DE	21010-EA010	<b>21082-VZ00A</b>		
	(14~)	2,488cc	QR25DE	21010-4JMOA	<b>21082-4JM1B</b>		
	(01~04)	3,498cc	VQ35DE	21046-4W000 (Bracket)	<b>21082-6P003</b>	21082-6P00A	
	(15~)	3,498cc	VQ35DE				
	(05~)	3,954cc	VQ40DE	21046-EA200 (Bracket)	<b>21082-EA200</b>	21082-ZK70A	
	(96~01)	4,130cc	VH41DE	21010-1P127	<b>21082-6P003</b>	21082-6P00A	
	(99~12)	4,479cc	TB45	21010-VB025	<b>21082-37J00</b>	21082-37J0A	
	(09~)	4,479cc	TB45E	21010-VB025	<b>21082-WK200</b>		
	(01~)	4,758cc	TB48DE	21010-VC225	<b>21082-VC200</b>	21082-VC20A	
	(04~15)	5,552cc	VK56DE	21046-7S000 (Bracket)	<b>21082-7S00A</b>	21082-7S001	
(10~)	5,552cc	VK56VD	21046-7S000 (Bracket)	<b>21082-5X20A (N/A)</b>			
Diesel	(97~08)	2,488cc	YD25DDTi/DDTi	<b>21010-VK525</b> <b>B1010-EB70A/VK525</b>	<b>21082-VB100</b>	21082-VB10A	
	(07~08)	2,488cc	YD25DDTi	<b>21010-EB70A/EB325</b>	<b>21082-EB70A</b>		
	(05~)	2,488cc	YD25DDTi (High Power)	<b>21010-EB70A/EB325</b>	<b>21082-EB70B/C</b>		
	(07~)	2,488cc	YD25DDTi (Mid Power)	<b>21010-EB300/OA</b> <b>21010-5X00A/B/C/D</b>	<b>21082-EB30A</b> <b>B1010-5X00D</b>	21082-LC10A <b>B1M10-5X00E</b>	
	(01~12)	2,953cc	ZD30DD	<b>21010-VW226</b> <b>B1010-VW20A</b>	<b>21010-VW227/28</b>	<b>21010-VW20A</b>	
	(97~10)	2,953cc	ZD30DDTi	<b>21010-2W225</b>	<b>21010-2W226/28</b>	<b>B1010-2W20A</b>	
	(02~07)	2,953cc	ZD30DDTi	<b>21010-VG126</b>	<b>21010-VG127/28</b>		
	(06~)	2,953cc	ZD30DDTi	<b>B1010-MA70A</b>	<b>21082-VS40A</b>		
	(99~)	4,169cc	TD42T	21010-34T28	<b>21082-1Y400</b>	21082-1Y40A	
	(86~96)	2,488*2,664cc	TD25*TD27	<b>21010-02N25</b>	<b>21010-02N03/26/27/28</b>	<b>21010-02N85~91</b>	<b>21010-22T25/26/27</b>
	(86~93)	2,664cc	TD27	<b>21010-43G25</b>	<b>21010-35V25/26/27</b>	<b>21010-43G26~29</b>	<b>21010-43G85~87/89</b>
	(97~01~)	2,664cc	TD27	<b>21010-2S526</b>	<b>21010-2S527</b>	<b>B1010-2S50A</b>	
	(87~95)	2,664cc	TD27 (4WD)	<b>21010-21N25</b>	<b>21010-21N26~29</b>	<b>21010-21N85/86</b>	<b>21010-21NY6</b>
	(97~01)	2,488cc	TD25	<b>21010-3S925</b>	<b>21010-3S90A</b>	<b>21010-3S926</b>	<b>21010-3S928</b>
	(86~94~)	2,664cc	TD27	<b>21010-80G25</b>	<b>21010-80G26~29</b>	<b>21010-80G85/86/88</b>	
	(93~05~)	2,664cc	TD27	<b>21010-7F400</b>	<b>21010-0F001/02/03/05</b>	<b>21010-7F401/OA</b>	<b>21010-G2401/04/05</b>
	(97~01~)	3,153cc	QD32	<b>21010-2S626</b>	<b>21010-2S627/28</b>	<b>B1010-2S60A</b>	
(93~00)	2,664cc	TD27	<b>21010-65N27</b>	<b>21010-65N85/87</b>	<b>21010-VH225</b>	<b>21010-VH025</b>	
(95~97)	2,664cc	TD27 (4WD)	<b>21010-65N28</b>	<b>21010-65N86/88</b>			
(95~97)	3,153cc	QD32	<b>21010-65N91</b>	<b>21010-F5N25</b>	<b>21010-65N89</b>		
(97~99)	3,153cc	QD32	<b>21010-0W828</b>	<b>21010-0W825/27/29</b>	<b>B1010-0W80A</b>		
(95~02)	3,153cc	QD32	<b>21010-2T325</b>	<b>21010-5T125/27/28</b>	<b>21010-6T325~28</b>	<b>21010-6T30A</b>	



# NISSAN

R Reverse Rotation

Item No.	Photo	Attachment	Size
21082-86G00 21082-86G0A			<b>Type A</b> A=134.0 B=119.8 C=45.0 D=11.5 E=31.96 F=60.0
21082-VW011			<b>Type A</b> A=143.0 B=128.8 C=45.0 D=11.5 E=31.96 F=60.0
21082-EA000 21082-EA00A 21082-EA01A  R			<b>Type A</b> A=153.0 B=136.8 C=67.1 D=11.5 E=31.96 F=60.0
21082-VZ00A			<b>Type A</b> A=143.0 B=128.8 C=45.0 D=11.5 E=31.96 F=60.0
21082-6P003 21082-6P00A			<b>Type A</b> A=153.0 B=135.8 C=60.0 D=11.5 E=31.96 F=60.0
21082-EA200 21082-ZK70A  R			<b>Type A</b> A=164.0 B=144.8 C=67.3 D=11.5 E=31.96 F=60.0

# NISSAN

R Reverse Rotation

Item No.	Photo	Attachment	Size
21082-37J00 21082-37J0A			<b>Type A</b> A=143.0 B=128.8 C=45.0 D=11.5 E=31.96 F=60.0
21082-WK200			<b>Type A</b> A=143.0 B=128.8 C=45.0 D=11.5 E=31.96 F=60.0
21082-VC200 21082-VC20A			<b>Type A</b> A=153.0 B=135.8 C=60.0 D=11.5 E=31.96 F=60.0
21082-7S00A 21082-7S001			<b>Type A</b> A=167.0 B=152.8 C=56.3 D=11.5 E=31.96 F=60.0
R			
21082-VB100 21082-VB10A			<b>Type A</b> A=143.0 B=128.8 C=62.3 D=11.5 E=31.96 F=60.0
21082-EB70A			<b>Type A</b> A=136.0 B=103.8 C=74.4 D=13.5 E=31.96 F=60.0

# NISSAN

Item No.	Photo	Attachment	Size
21082-EB70B 21082-EB70C			<b>Type A</b> A=177.0 B=159.8 C=68.4 D=11.5 E=31.96 F=60.0
21082-EB30A 21082-LC10A			<b>Type A</b> A=136.0 B=103.8 C=74.4 D=13.5 E=31.96 F=60.0
21082-VS40A			<b>Type A</b> A=177.0 B=159.8 C=55.0 D=11.9 E=31.60 F=77.5
21082-1Y400 21082-1Y40A			<b>Type A</b> A=143.0 B=128.8 C=45.0 D=11.5 E=31.96 F=60.0
21010-VW226 21010-VW227/28 21010-VW20A B1010-VB20A			<b>Type A</b> A=143.0 B=128.8
21010-2W225 21010-2W226/28 B1010-2W20A			<b>Type A</b> A=143.0 B=128.8



# NISSAN

Item No.	Photo	Attachment	Size
<p>21010-VG126 21010-VG127/28</p>			<p><b>Type A</b> A=143.0 B=128.8</p>
<p>21010-02N25 21010-02N03/26/27/28 21010-02N85~91 21010-22T25/26/27</p>			<p><b>Type A</b> A=134.0 B=119.8</p>
<p>21010-43G25 21010-35V25/26/27 21010-43G26~29 21010-43G85~87/89</p>			<p><b>Type A</b> A=134.0 B=119.8</p>
<p>21010-2S526 21010-2S527 B1010-2S50A</p>			<p><b>Type A</b> A=134.0 B=119.8</p>
<p>21010-21N25 21010-21N26~29 21010-21N85/86 21010-21NY6</p>			<p><b>Type A</b> A=134.0 B=119.8</p>
<p>21010-3S925 21010-3S90A 21010-3S926 21010-3S928</p>			<p><b>Type A</b> A=143.0 B=128.8</p>

# NISSAN

Item No.	Photo	Attachment	Size
<p><b>21010-80G25</b>            21010-80G26~29            21010-80G85/86/88</p>			<p><b>Type A</b>            A=143.0            B=128.8</p>
<p><b>21010-7F400</b>            21010-0F001/02/03/05            21010-7F401/0A            21010-G2401/04/05</p>			<p><b>Type A</b>            A=143.0            B=128.8</p>
<p><b>21010-2S626</b>            21010-2S627/28            B1010-2S60A</p>			<p><b>Type A</b>            A=143.0            B=128.8</p>
<p><b>21010-65N27</b>            21010-65N85/87            21010-VH225            21010-VH025</p>			<p><b>Type A</b>            A=143.0            B=128.8</p>
<p><b>21010-65N28</b>            21010-65N86/88</p>			<p><b>Type A</b>            A=143.0            B=128.8</p>
<p><b>21010-65N91</b>            21010-F5N25            21010-65N89</p>			<p><b>Type A</b>            A=143.0            B=128.8</p>

# NISSAN

Item No.	Photo	Attachment	Size
<p>21010-0W828 21010-0W825/27/29 B1010-0W80A</p>			<p><b>Type A</b> A=143.0 B=128.8</p>
<p>21010-2T325 21010-5T125/27/28 21010-6T325~28 21010-6T30A</p>			<p><b>Type A</b> A=143.0 B=128.8</p>
<p>21010-VK525 21010-EB300 21010-EB70A 21010-5X00A</p>			









	Year	Displacement	Engine Model	Water Pump No.	Fan Clutch No.	Cross Reference No.1	Cross Reference No.2
--	------	--------------	--------------	----------------	----------------	----------------------	----------------------

## MITSUBISHI/FUSO

### Items in last 20 years







Gasoline	(97~)	1,997cc	4G63		MD361311		
	(87~06)	1,997cc	4G63	MD972934	MD317679	MD326227	
	(97~07)	2,351cc	4G64	MD972934	MD317679	MD326227	
	(08~)	2,379cc	4G69	1320A072	MN155777		
	(93~02)	2,972cc	6G72	MD972004	MD106546	MD142419	
	(94~96)	2,972cc	6G72	MD972004	MD303502		
	(97~02)	2,972cc	6G72	MD979169	MD335271		
	(96~01)	2,972cc	6G72	MD974999	MD331586	MD331638	
	(94~96)	3,500cc	6G74	MD972440	MD303502		
	(96~03)	3,500cc	6G74	MD972440	MD334660	MN119786	
(08~10)	3,500cc		MD979171	1320A019			
(00~)	3,827cc	6G75	MD979171	MD356867	MN176301		
Diesel	(87~01)	2,477cc	4D56	MD972001	MD106546	MD050472	
	(96~07)	2,477cc	4D56	MD974999	MD331586	MD359040	
	(05~)	2,477cc	4D56 (w/Turbo)	1320A045	1320A009	1320A032	1320A051
	(05~07)	2,477cc	4D56 (w/o Turbo)	MD974748	1320A011		
		2,835cc	4M40	ME996792	ME298566	ME299217	
	(06~)	2,977cc	4M42		ME412758	ME402555	
	(96~07)	2,835cc	4M40	ME993473	ME201754	ME202147	
	(07~09)	2,835cc	4M40 (TURBO)	ME993473	ME298543		
	(00~06)	3,200cc	4M41 (TURBO)	ME993473	ME298543		
	(06~)	3,200cc	4M41	1300A074/102	1320A010	1320A033	
	(98~)	4,899cc	4M50	Braket(Fan Pulley)	ME408612	ME411658	
	(07~)	5,249cc	4M51	Braket(Fan Pulley)	ME240908		
(11~)	2,998cc	4P10		ME418337 (In Deverpment)			

# MITSUBISHI/FUSO







Item No.	Photo	Attachment	Size
MD361311			<p><b>Type A</b></p> <p>A=122.0 B=103.8 C=72.1 D=16.0 E=18.26 F=48.0</p>
MD317679 MD326227			<p><b>Type A</b></p> <p>A=153.0 B=136.8 C=52.7 D=14.0 E=18.26 F=48.0</p>
MN155777			<p><b>Type A</b></p> <p>A=153.0 B=136.8 C=52.7 D=14.0 E=18.26 F=48.0</p>
MD106546 MD142419			<p><b>Type A</b></p> <p>A=153.0 B=136.8 C=61.4 D=10.0 E=24.16 F=56.0</p>
MD303502			<p><b>Type A</b></p> <p>A=153.0 B=136.8 C=55.0 D=10.0 E=24.16 F=56.0</p>
MD335271			<p><b>Type A</b></p> <p>A=153.0 B=136.8 C=58.0 D=10.0 E=24.16 F=56.0</p>

# MITSUBISHI/FUSO

R Reverse Rotation

Item No.	Photo	Attachment	Size
<p>MD331586 MD331638/39</p>			<p><b>Type A</b> A=153.0 B=136.8 C=66.6 D=10.0 E=24.16 F=56.0</p>
<p>MD334660 MN119786</p>			<p><b>Type A</b> A=153.0 B=136.8 C=58.0 D=10.0 E=24.16 F=56.0</p>
<p>1320A019</p>			<p><b>Type A</b> A=177.0 B=159.8 C=73.5 D=12.0 E=24.16 F=56.0</p>
<p>MD356867 MN176301</p> <p>R</p>			<p><b>Type A</b> A=177.0 B=159.8 C=73.7 D=12.0 E=24.16 F=56.0</p>
<p>1320A009 1320A032 1320A051</p>			<p><b>Type A</b> A=177.0 B=159.8 C=73.7 D=12.0 E=24.16 F=56.0</p>
<p>1320A011</p>			<p><b>Type A</b> A=177.0 B=159.8 C=79.7 D=12.0 E=24.16 F=56.0</p>

# MITSUBISHI/FUSO

Item No.	Photo	Attachment	Size
ME298566 ME299217			<b>Type A</b> A=177.0 B=159.8 C=74.3 D=7.0 E=34.26 F=64.0
ME412758 ME402555			<b>Type A</b> A=177.0 B=159.8 C=74.3 D=7.0 E=34.26 F=64.0
ME201754 ME202147			<b>Type A</b> A=153.0 B=136.8 C=37.2 D=7.5 E=18.50 F=120.0
ME298543			<b>Type A</b> A=177.0 B=159.8 C=50.0 D=7.5 E=18.50 F=120.0
1320A010 1320A033			<b>Type A</b> A=177.0 B=159.8 C=50.0 D=7.5 E=18.50 F=120.0
ME408612 ME411658			<b>Type A</b> A=177.0 B=159.8 C=74.0 D=17.5 E=46.10 F=114.0



# MITSUBISHI/FUSO

Item No.	Photo	Attachment	Size
ME240908			<b>Type A</b> A=177.0 B=159.8 C=54.2 D=11.0 E=46.10 F=114.0

	Year	Displacement	Engine Model	Water Pump No.	Fan Clutch No.	Cross Reference No.1	Cross Reference No.2
--	------	--------------	--------------	----------------	----------------	----------------------	----------------------



## ISUZU

### Items of very old model which are not "picked up"

Gasoline	(03~04)	3,165cc	6VD1	8-97167-554-0	8-97349-761-0	8-97329-954-0		
	(03~)	3,494cc	6VE1	8-97167-554-0	8-97349-761-0	8-97329-954-0		
Diesel	(89~)	2,499cc	4JA1	8-94140-341-2	8-94244-409-0	8-94145-322-0		
	(01~)	2,499cc	4JA1	8-94140-341-2	8-97039-034-0			
	(05~)	2499*Diesel	4JK1	8-97105 012-3	8-97302-291-0			
	(85~06)	2771*Diesel	4JB1	8-94376-851-0	8-94311-257-0			
	(91~02)	3059*Diesel	4JG2	8-97105 012-3	8-97129-735-0			
	(07~)	2771*Diesel	4JB1-TC	8-97105 012-3	8-97129-735-0			
	(03~06)	2999*Diesel	4JJ1-TC	8-97105 012-3	8-97302-291-0			
	(07~)	2999*Diesel	4JJ1-TC (4JH1)	8-97312-147-3	8-97944-149-1	8-98119-213-1		
	(95~)	4334*Diesel	4HF1	8-97333 361-0	8-97129-738-0			
	(02~04)	4570*Diesel	4HG1	8-97333 361-0	8-97139-299-0			
	(98~05)	4751*Diesel	4HE1	8-97333-610-0	8-97148-797-0			
			4777*Diesel	4HL1		8-97330-208-0		
			4985*Diesel	4HJ1		8-97330-208-0		
	(04~)	5193*Diesel	4HK1-TC	8-97103-857-0	8-97367-382-0			
	(07~)	5193*Diesel	4HK1-TC	8-97363-478-0	8-98019-743-0			
(11~)	5193*Diesel	4HK1-TCN	8-98004-292-2	8-98024-684-0				

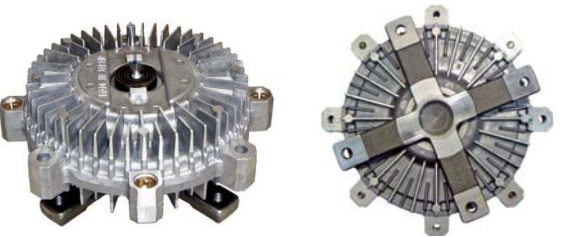
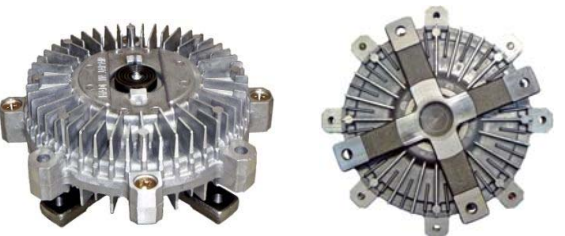
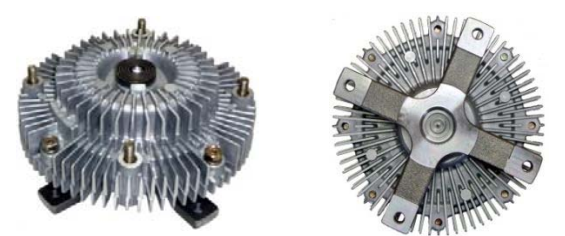

Item No.	Photo	Attachment	Size
<p>8-97349-761-0 8-97329-954-0</p> <p><b>R</b></p>			<p><b>Type A</b></p> <p>A=164.0 B=144.8 C=63.1 D=23.5 E=16.16 F=62.0</p>
<p>8-94244-409-0 8-94145-322-0</p>			<p><b>Type A</b></p> <p>A=122.0 B=103.8 C=55.5 D=15.5 E=32.16 F=60.0</p>
<p>8-97039-034-0</p>			<p><b>Type A</b></p> <p>A=136.0 B=103.8 C=73.7 D=15.5 E=32.16 F=60.0</p>
<p>8-97302-291-0</p>			<p><b>Type A</b></p> <p>A=136.0 B=103.8 C=79.8 D=15.5 E=32.16 F=60.0</p>
<p>8-94311-257-0</p>			<p><b>Type A</b></p> <p>A=134.0 B=119.8 C=48.0 D=15.5 E=32.16 F=60.0</p>
<p>8-97129-735-0</p>			<p><b>Type A</b></p> <p>A=153.0 B=136.8 C=67.1 D=15.5 E=32.16 F=60.0</p>

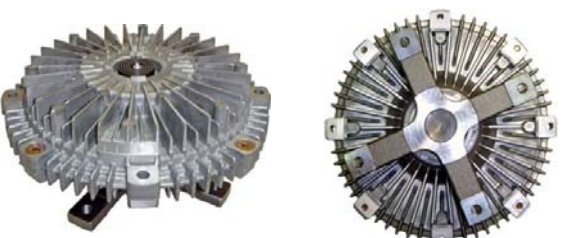
# ISUZU

Item No.	Photo	Attachment	Size
<p>8-97944-149-1 8-98119-213-1</p>			<p><b>Type A</b> A=177.0 B=159.8 C=70.4 D=15.5 E=32.16 F=60.0</p>
<p>8-97129-738-0</p>			<p><b>Type A</b> A=153.0 B=136.8 C=35.4 D=7.2 E=22.56 F=130.0</p>
<p>8-97139-299-0</p>			<p><b>Type A</b> A=153.0 B=136.8 C=35.4 D=7.2 E=22.56 F=130.0</p>
<p>8-97148-797-0</p>			<p><b>Type A</b> A=136.0 B=103.8 C=57.1 D=11.5 E=22.60 F=130.0</p>
<p>8-97330-208-0</p>			<p><b>Type A</b> A=177.0 B=159.8 C=45.0 D=7.5 E=22.56 F=130.0</p>
<p>8-97367-382-0</p>			<p><b>Type A</b> A=177.0 B=159.8 C=57.7 D=7.0 E=22.50 F=130.0</p>

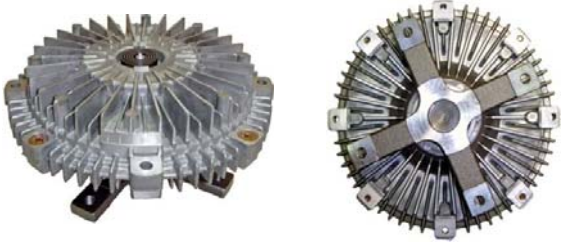

# ISUZU

Item No.	Photo	Attachment	Size
8-98019-743-0			<b>Type A</b> A=177.0 B=159.8 C=65.5 D=7.0 E=22.5 F=130.0
8-98024-684-0			<b>Type A</b> A=177.0 B=159.8 C=93.4 D=15.5 E=32.16 F=60.0







	Year	Displacement	Engine Model	Water Pump No.	Fan Clutch No.	Cross Reference No.1	Cross Reference No.2
--	------	--------------	--------------	----------------	----------------	----------------------	----------------------

## MAZDA (Ford)

### Items of very old model which are not "picked up"

<b>Gasoline</b>	(89~94)	1,998cc	FE	8AG1-15-010B	FE65-23-907		
	(89~02)	2,200cc	F2	8AK1-15-010A	FE66-23-907		
G.C.C	(02~06)	2,200cc	F2	8AK1-15-010A	F21E-15-150		
GEN*ECU*COL	(02~06)	2,200cc	F2	8AK1-15-010A	FE66-23-907		
[Radiator STD Type]	(90~06)	2,600cc	G6-E	8AL1-15-010C	G607-15-150A	G503-15-150	G601-15-150A
[Radiator Heavy Type]	(05~06)	2,600cc	G6-E	8AL1-15-010C	G683-15-150		
G.C.C	(06~11)	2,200cc	F2E	FEMJ-15-100	F21E-15-150		
GEN*ECU*COL	(06~11)	2,200cc	F2E	FEMJ-15-100	FE66-23-907		
[Radiator STD Type]	(06~11)	2,600cc	G6-E	G601-15-010D	G607-15-150A	G503-15-150	G601-15-150A
[Radiator Heavy Type]	(06~11)	2,600cc	G6-E	G601-15-010D	G683-15-150		
<b>Diesel</b>	(97~04)	2,499cc	WL-T	WL81-15-100C	WL21-15-150	WL61-15-150	WL81-15-150A
	(06~)	2,499cc	MZR-CD (G5/WLC)		WE01-15-150		
	(06~11)	2,953cc	MZR-CD (WEC)		WE01-15-150		

## MAZDA (Ford)

Item No.	Photo	Attachment	Size
FE65-23-907			<b>Type B</b> A=130.0 B=111.8 C=40.2 D=15.0 E=24.26 F=56.0
FE66-23-907			<b>Type B</b> A=130.0 B=111.8 C=40.2 D=15.0 E=24.26 F=56.0
F21E-15-150			<b>Type A</b> A=153.0 B=136.8 C=52.8 D=15.0 E=24.16 F=56.0
G607-15-150A G503-15-150 G601-15-150A			<b>Type A</b> A=153.0 B=136.8 C=54.8 D=11.5 E=17.76 F=56.0
G683-15-150			<b>Type A</b> A=153.0 B=136.8 C=47.5 D=18.5 E=17.76 F=56.0
WL-21-15-150 WL61-15-150 WL81-15-150A			<b>Type B</b> A=139.0 B=122.8 C=42.6 D=8.5 E=16.16 F=50.0

**MAZDA (Ford)**

Item No.	Photo	Attachment	Size
WE01-15-150			<p><b>Type A</b></p> <p>A=177.0 B=159.8 C=71.2 D=8.5 E=16.16 F=50.0</p>





	Year	Displacement	Engine Model	Water Pump No.	Fan Clutch No.	Cross Reference No.1	Cross Reference No.2
--	------	--------------	--------------	----------------	----------------	----------------------	----------------------

## SUZUKI

Items of very old model which are not "picked up"

Gasoline	(86~89)	1,324cc	G13B*M13A	17400-83810	<b>17120-60A00</b>	17120-60A01	17120-83000
	(90~98)	1,324cc	G13B*M13A	17400-83810	<b>17120-57B00</b>	17120-57B01	
	(99~)	1,324cc	G13B*M13A	17400-83810	<b>17120-57B00</b>	17120-57B01	17120-81A00
	(96~98)	1,590cc	G16B	17400-61820	<b>17120-57B00</b>	17120-57B01	
	(99~02)	1,590cc	G16B	17400-61820	<b>17120-57B00</b>	17120-57B01	
	(99~05)	1,998cc	J20A*H20A	17400-77810	<b>17120-77E00</b>	17120-77E01/02	17120-77E05/07
	(99~05)	2,493cc	H25A	17400-85830	<b>17120-77E00</b>	17120-77E01/02	17120-77E05/07
	(08~)	2,488cc	QR25DE	17400-82Z10	<b>17120-82Z20</b>	21082-EA000	
	(01~04)	2,736cc	H27A	17400-85830	<b>17120-52D00</b>	17120-52D01	
	(04~06)	2,736cc	H27A	17400-85830	<b>17120-52D10</b>		
Diesel	(08~)	3,954cc	VQ40DE	Braket(Fan Pulley)	<b>17120-82Z10</b>	21082-EA200	
	(99~05)	2,000cc	RF*RHW	17400-78E00	<b>17120-68D00</b>		

# SUZUKI

Item No.	Photo	Attachment	Size
<b>17120-60A00</b> 17120-60A01 17120-83000			<b>Type A</b> A=98.0 B=81.8 C=47.1 D=6.5 E=24.16 F=40.0
<b>17120-57B00</b> 17120-57B01			<b>Type A</b> A=98.0 B=81.8 C=51.0 D=6.5 E=24.16 F=40.0
<b>17120-77E00</b> 17120-77E01/02 17120-77E05/07			<b>Type A</b> A=153.0 B=136.8 C=57.5 D=17.5 E=16.16 F=50.0
<b>17120-52D00</b> 17120-52D01			<b>Type A</b> A=153.0 B=136.8 C=57.5 D=17.5 E=16.16 F=50.0
<b>17120-52D10</b>			<b>Type A</b> A=164.0 B=144.8 C=60.9 D=17.5 E=16.16 F=50.0
<b>17120-68D00</b>			<b>Type A</b> A=153.0 B=136.8 C=55.8 D=14.0 E=16.16 F=50.0

**SUZUKI**

**R** Reverse Rotation

Item No.	Photo	Attachment	Size
<p><b>17120-82Z10</b> 21082-EA000</p> <p><b>R</b></p>			<p><b>Type A</b></p> <p>A=164.0 B=144.8 C=67.3 D=11.5 E=31.96 F=60.0</p>
<p><b>17120-82Z20</b> 21082-EA000</p> <p><b>R</b></p>			<p><b>Type A</b></p> <p>A=153.0 B=136.8 C=67.1 D=11.5 E=31.96 F=60.0</p>

**\*\*We can also supply many items not included in this catalog\*\***



*etc. ...*



**Shimahide**

**MADE IN JAPAN**  
[www.shimahide.jp](http://www.shimahide.jp)